

Paneelsysteem Waterfall

- Paneelsysteem uit aluminium voor 6 mm dikke glazen achterwanden.



Bovenprofiel Waterfall WF2

Montagewijze: schroefmontage
 Lengte: 3000 mm

Art.nr.	Materiaal	EH	prijs EUR	per
103 353 750	Aluminium natuur geanodiseerd	ST	26,20	1 ST

productgroep 300

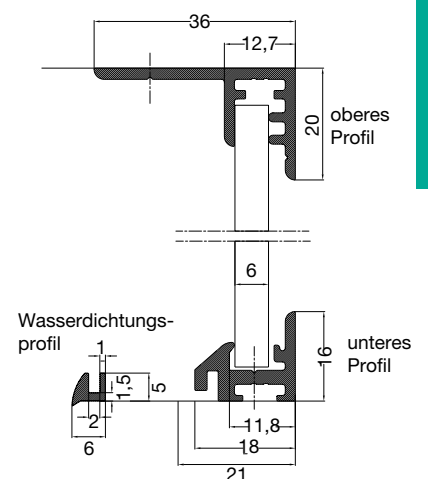
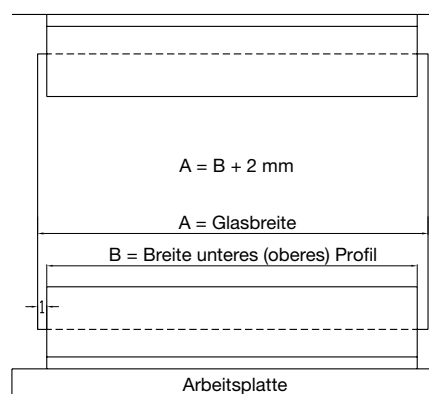
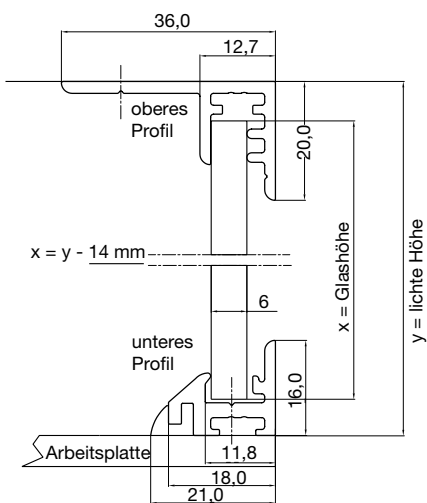

5

Onderprofiel Waterfall WF1

Montagewijze: schroefmontage
 Lengte: 3000 mm

Art.nr.	Materiaal	EH	prijs EUR	per
103 353 751	Aluminium natuur geanodiseerd	ST	19,10	1 ST

productgroep 300



90° hoekprofiel Waterfall WF4

- Voor gebruik in onderste (WF1) en bovenste profiel (WF2).

Lengte: 3000 mm

Art.nr.	Materiaal	EH	prijs EUR	per
103 353 755	Aluminium natuur geanodiseerd	ST	17,45	1 ST

productgroep 300

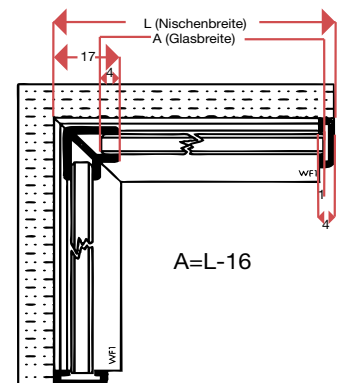
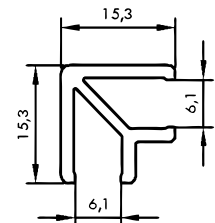
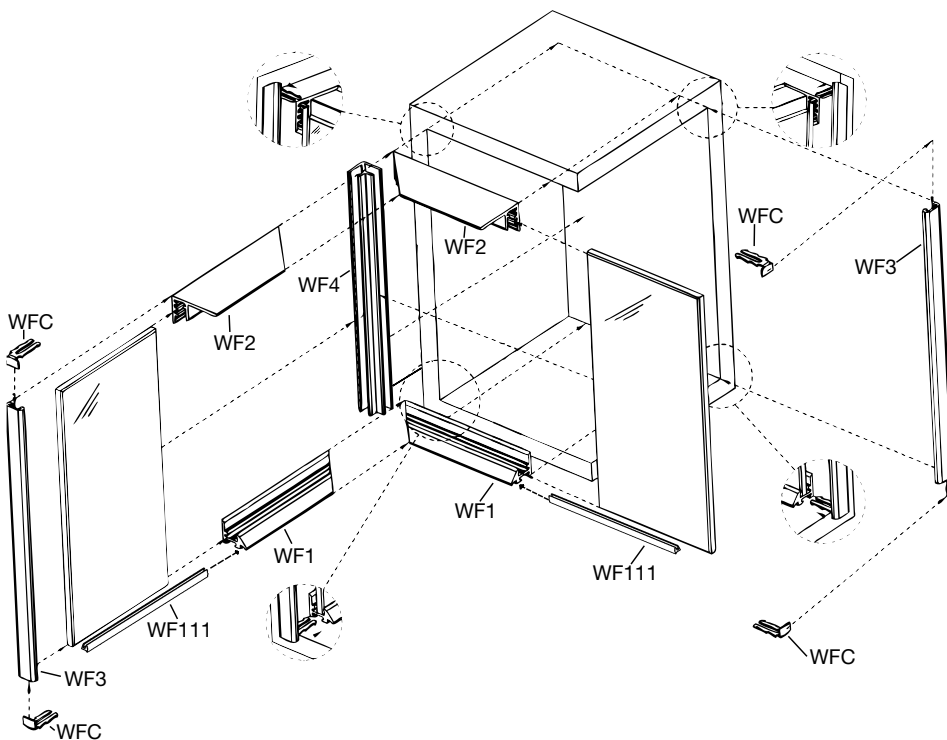

5

Waterdichtingsprofiel Waterfall WF111

- voor onderprofiel WF1

Lengte: 3000 mm

Art.nr.	Materiaal	EH	prijs EUR	per
103 353 752	Kunststof transparant	ST	5,19	1 ST

productgroep 300

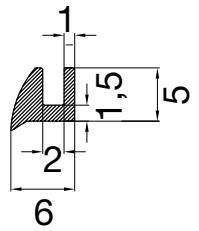

Zijprofiel Waterfall WF3

- voor klikmontage - met behulp van 2 bevestigingsklemmen WFC (apart bestellen) - in boven- (WF2) en onderprofiel (WF1)

Lengte: 3000 mm

Art.nr.	Materiaal	EH	prijs EUR	per
103 353 753	Aluminium natuur geanodiseerd	ST	11,75	1 ST

productgroep 300

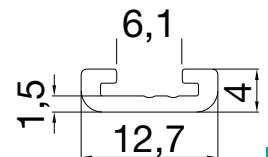

Bevestigingsklem Waterfall WFC

- voor montage van het zijprofiel WF3 in boven- (WF2) en onderprofiel (WF1)

Art.nr.	Materiaal	EH	prijs EUR	per
103 353 754	Staal	ST	0,56	1 ST

productgroep 300

