

Klant		Contact	
Straat + n°		Fax	
Postcode		Telefoon	
Stad			
Land		Referentie	
E-mail		Datum	

Ladezijden
Zijdewit
Grijs metallic
Terrazwart

Bodem + rug
Wit
Lichtgrijs
Donkergrijs
Bruinzwart

Geleiders
Blumotion
Tip-on Blumotion

Frontbevestigingen
Inserta
Schroefversie
Voor alu-front

Opvullijst <sup>(4)</sup>
Wit
Platina zilvergrijs
Oriongrijs
Zwart

Verpakking
V1
ProBOX <sup>(2)</sup>

Inlegmatten
Flock
Kunststof-fiber

Inschuifelement
Metaal
Helder glas
Gezuurd glas

Specificaties - uitbreiding sifonlade <sup>(6)</sup> en spoelbaklade							
Type lade	Enkele sifonlade Dubbele sifonlade Spoelbaklade	Enkele sifonlade Dubbele sifonlade Spoelbaklade	Dubbele sifonlade	Dubbele sifonlade	Enkele sifonlade Dubbele sifonlade Spoelbaklade	Contole binnenmaat ENKEL	Contole binnenmaat DUBBEL
Nr.	X <sup>(7)</sup>	Z1 <sup>(160 mm bij sifonlades)</sup>	M <sup>(8)</sup>	Z2	Y <sup>(7)</sup>		
	mm	mm	mm	160 mm	mm		
	mm	mm	mm	160 mm	mm		
	mm	mm	mm	160 mm	mm		
	mm	mm	mm	160 mm	mm		
	mm	mm	mm	160 mm	mm		
	mm	mm	mm	160 mm	mm		

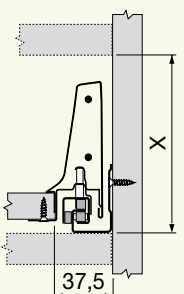
Nodige inbouwruimte <sup>(9)</sup>															
	<table border="1"> <thead> <tr> <th>XM</th> <th>in.</th> </tr> </thead> <tbody> <tr> <td>N8</td> <td>2</td> </tr> <tr> <td>M9</td> <td>8,5</td> </tr> <tr> <td>K1</td> <td>30,5</td> </tr> <tr> <td>B1</td> <td>60</td> </tr> <tr> <td>CM</td> <td>192</td> </tr> <tr> <td>DM</td> <td>224</td> </tr> </tbody> </table>	XM	in.	N8	2	M9	8,5	K1	30,5	B1	60	CM	192	DM	224
XM	in.														
N8	2														
M9	8,5														
K1	30,5														
B1	60														
CM	192														
DM	224														

- Symmetrisch profiel, dikte 25 mm
- Minimale bestelhoeveelheid: 4 mm
- Zie volgende pagina's
- De draagkracht is afhankelijk van de Lengte: zie tabel volgend pagina
- Wordt aanbevolen bij brede ondiepe lades
- Steeds M rugwanden bij sifonlades
- W en Y kunnen variabel zijn, maar moeten minimaal 133,5 mm zijn
- M kan variabel zijn, maar moet minimaal 97 mm zijn
- Inclusief vrije ruimte om de lade in te hangen

Opmerkingen

**MAATVOERING SPOELBAKLADE**

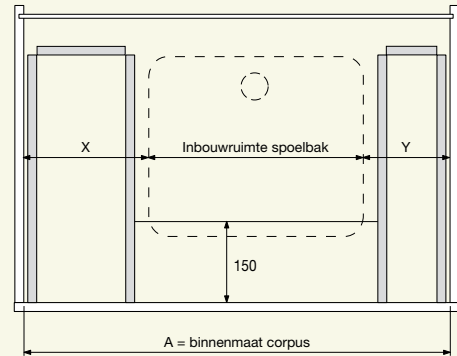
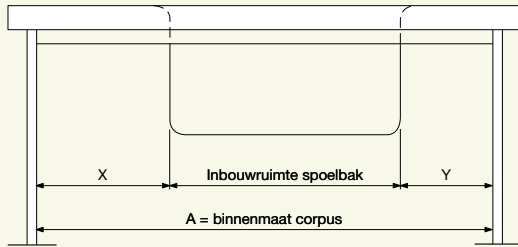

**MAATVOERING ENKELE SIFONLADE**

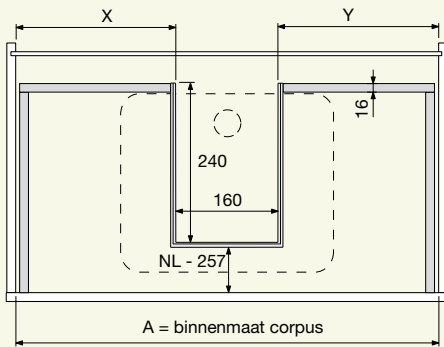

**MAATVOERING DUBBELE SIFONLADE**

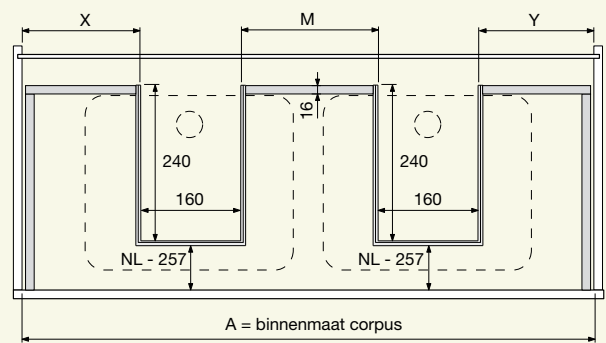

SPOELBAKLADE

**MS**

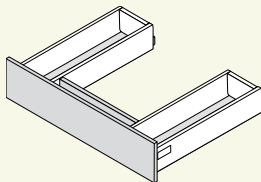

**BS**

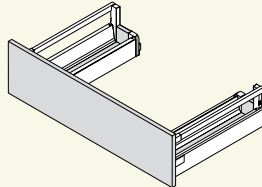

**CMS**

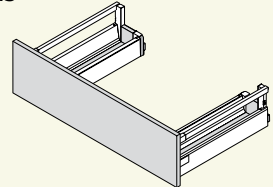

**DMS**

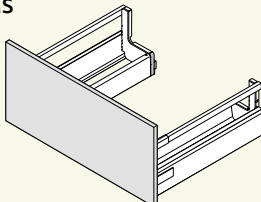

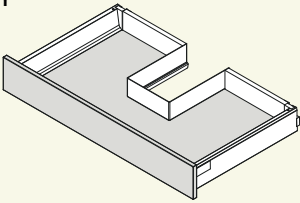
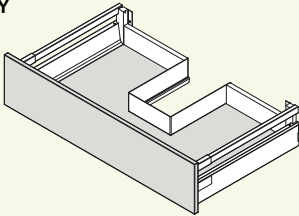
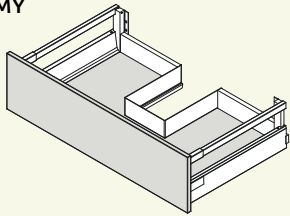
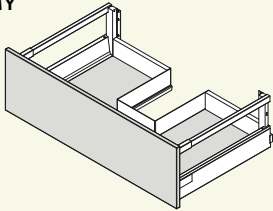
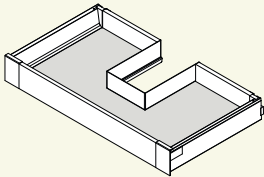
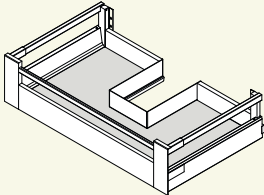
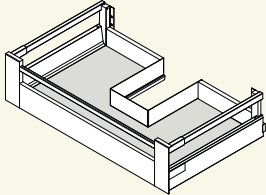
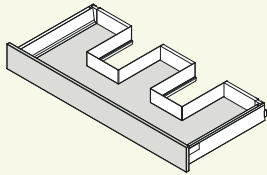
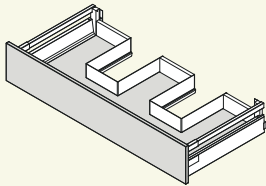
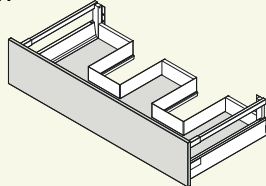
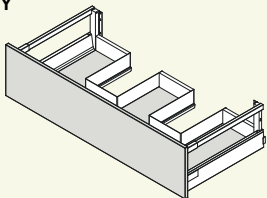
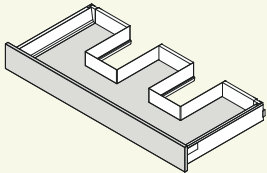
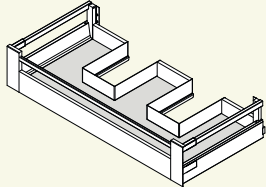
ENKELE SIFONLADE	MY 	BY 	CMY 
	DMY 		
ENKELE SIFONBINNENLADE	MY/Z 	CMY/Z 	DMY/Z 
DUBBELE SIFONLADE	MY 	BY 	CMY 
	DMY 		
DUBBELE SIFONBINNENLADE	MY/Z 	CMY/Z 	DMY/Z 