

DECEUNINCK DEFORCE
EXPERT IN DEUR- EN MEUBELBESLAG

DEUR- EN MEUBELPIVOTS

- 3.0 -





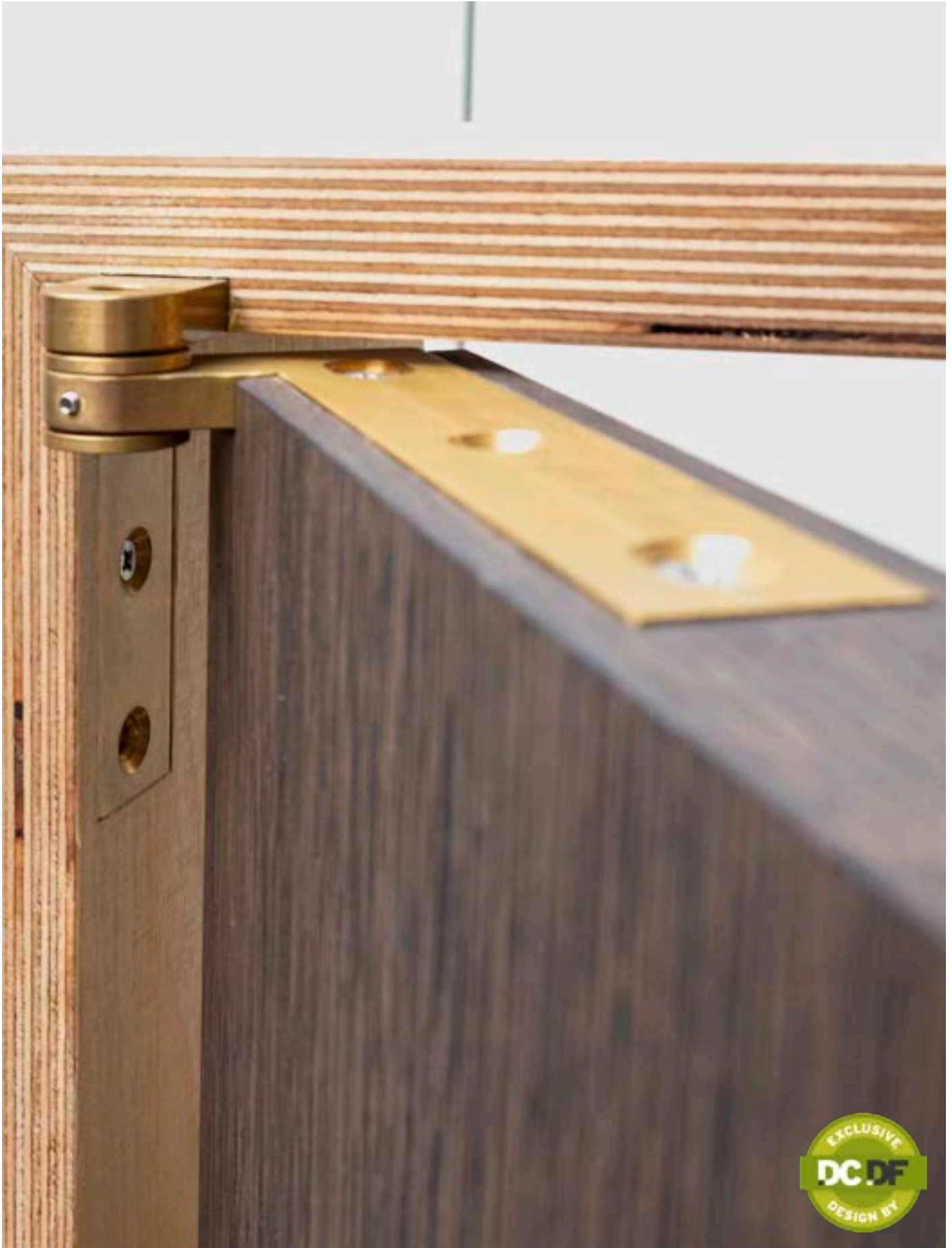

Deurpivot buitendraaiend maatwerk	4
Deurpivot smeedijzer	6
Meubelpivot buitendraaiend maatwerk	9
Meubelpivot divers	11
Meubelpivot smeedijzer	15
Beschikbare kleuren maatwerk pivots	17
Onderdelen deurpivot	18
Onderdelen meubelpivot	20
Fritsjurgens	22
Argenta / Pivotica	24
CIR onzichtbaar	25
Deurpivot divers	26

INHOUD

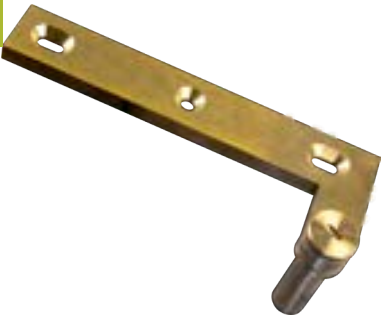

<p>1D</p> 	<p style="text-align: right;">101 101A</p> <p>BOVEN- / ONDERPIVOT</p> <p>Onderdelen (p. 18): D of E + H + J + K</p>
<p>2D</p> 	<p style="text-align: right;">102 102A</p> <p>BOVEN- / ONDERPIVOT</p> <p>Onderdelen (p. 18): B of C + D of E + I + K</p>
<p>3D</p> 	<p style="text-align: right;">130</p> <p>BOVEN- / ONDERPIVOT</p> <p>Onderdelen (p. 18): D of E + A + I + K</p>
<p>4D</p> 	<p style="text-align: right;">126</p> <p>BOVEN- / ONDERPIVOT Bruikbaar als boven rechts / onder links Zijdellingse montage</p> <p>Onderdelen (p. 18): D of E + G + I + K</p>
<p>5D</p> 	<p style="text-align: right;">124</p> <p>BOVEN- / ONDERPIVOT Bruikbaar als boven links / onder rechts Zijdellingse montage</p> <p>Onderdelen (p. 18): D of E + F + I + K</p>



1 deur = 1 x bovenpivot + 1 x onderpivot
Beschikbare kleuren pagina 17.

6D



104

BOVEN- / ONDERPIVOT*

Links en rechts bruikbaar

Onderdelen (p. 20):

X + **D** + **I** + **K**

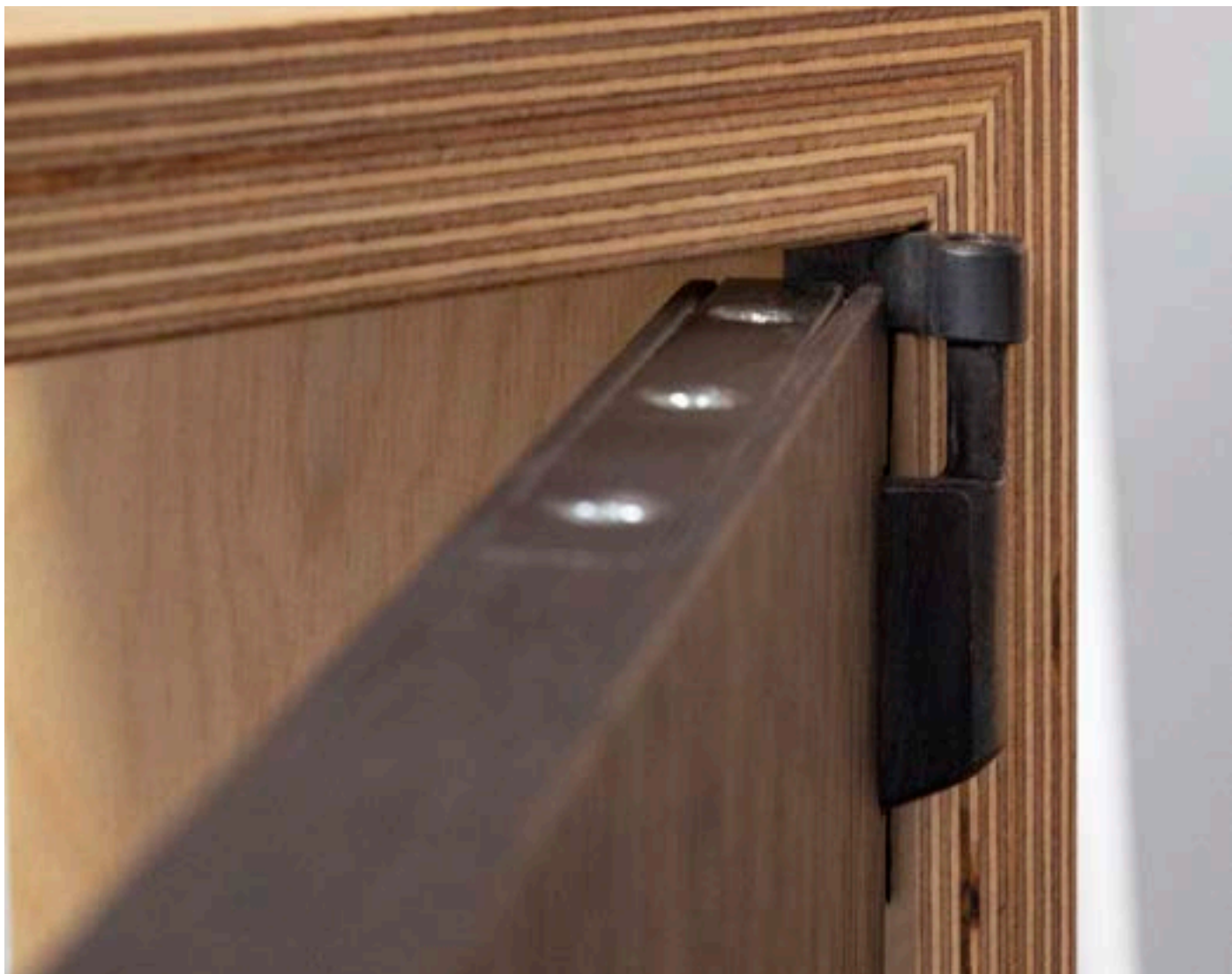





BDPHK

Smeedijzer pivot
Boven en onder

Verkocht per paar (= 1 deur)

Enkel beschikbaar in gestookt onbehandeld ijzer

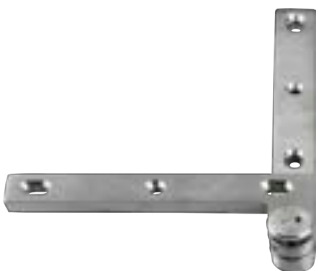

<p>1M</p> 	<p style="text-align: right;">201</p> <p>BOVEN- / ONDERPIVOT</p> <p>Onderdelen (p. 20): M + T + V + W</p>
<p>2M</p> 	<p style="text-align: right;">203</p> <p>BOVEN- / ONDERPIVOT</p> <p>Onderdelen (p. 20): O + T + V + W ■</p>
<p>3M</p> 	<p style="text-align: right;">202</p> <p>BOVEN- / ONDERPIVOT</p> <p>Onderdelen (p. 20): N + M + U + W</p>
<p>4M</p> 	<p style="text-align: right;">230</p> <p>BOVEN- / ONDERPIVOT</p> <p>Onderdelen (p. 20): M + L + U + W</p>
<p>5M</p> 	<p style="text-align: right;">206</p> <p>BOVEN- / ONDERPIVOT</p> <p>Onderdelen (p. 20): P + O + U + W</p>

1 deur = 1 x bovenpivot + 1 x onderpivot
Beschikbare kleuren pagina 17.



<p>6M</p> 	<p style="text-align: right;">226</p> <p>BOVEN- / ONDERPIVOT* Bruikbaar als boven rechts / onder links</p> <p>Onderdelen (p. 20): S + M + U + W</p>
<p>7M</p> 	<p style="text-align: right;">224</p> <p>BOVEN- / ONDERPIVOT* Bruikbaar als boven links / onder rechts</p> <p>Onderdelen (p. 20): R + M + U + W</p>
<p>8M</p> 	<p style="text-align: right;">204</p> <p>BOVEN- / ONDERPIVOT* Links en rechts bruikbaar</p> <p>Onderdelen (p. 20): Q + M + U + W</p>
<p>NIEUW</p> 	<p>PIV307F Bovenpivot en onderpivot (L / R) voor stalen deur</p> <p>Verkocht per set (= 1 deur)</p> <p>Uitvoering staal, afwerking gefosfateerd Ook beschikbaar in blank staal (op bestelling)</p>

* 1 deur = 1 x bovenpivot + 1 x onderpivot
Beschikbare kleuren pagina 17.



	<p>PIV300LF Bovenpivot (L / R) Verkocht per paar</p> <p>(1 deur = 1 set = 1 x PIV300LF + 1 x PIV100RF)</p> <p>Uitvoering staal, afwerking gefosfateerd Ook beschikbaar in blank staal (op bestelling)</p>
	<p>PIV300RF Onderpivot (L / R) Verkocht per paar</p> <p>(1 deur = 1 set = 1 x PIV300LF + 1 x PIV100RF)</p> <p>Uitvoering staal, afwerking gefosfateerd Ook beschikbaar in blank staal (op bestelling)</p>
	<p>PIV301F Middenpivot Verkocht per paar</p> <p>Uitvoering staal, afwerking gefosfateerd Ook beschikbaar in blank staal (op bestelling)</p>
	<p>PIV302F Bovenpivot (L / R) Verkocht per paar</p> <p>(1 deur = 1 set = 1 x PIV302F + 1 x PIV303F)</p> <p>Uitvoering staal, afwerking gefosfateerd Ook beschikbaar in blank staal (op bestelling)</p>
	<p>PIV303F Onderpivot (L / R) Verkocht per paar</p> <p>(1 deur = 1 set = 1 x PIV302F + 1 x PIV303F)</p> <p>Uitvoering staal, afwerking gefosfateerd Ook beschikbaar in blank staal (op bestelling)</p>





	<p>YC707550L Bovenpivot (L / R) Verkocht per paar</p> <p>(1 deur = 1 set = 1 x YC707550L + 1 x YC707550R)</p> <p>Enkel beschikbaar in niet behandelde messing</p>	<p>20 x 50 mm</p>
	<p>YC707550R Onderpivot (L / R) Verkocht per paar</p> <p>(1 deur = 1 set = 1 x YC707550L + 1 x YC707550R)</p> <p>Enkel beschikbaar in niet behandelde messing</p>	<p>20 x 50 mm</p>
	<p>YC707580L Bovenpivot (L / R) Verkocht per paar</p> <p>(1 deur = 1 set = 1 x YC707580L + 1 x YC707580R)</p> <p>Enkel beschikbaar in niet behandelde messing</p>	<p>25 x 80 mm</p>
	<p>YC707580R Onderpivot (L / R) Verkocht per paar</p> <p>(1 deur = 1 set = 1 x YC707580L + 1 x YC707580R)</p> <p>Enkel beschikbaar in niet behandelde messing</p>	<p>25 x 80 mm</p>



	<p>SUGPAW50 Inox wandmontage Boven en onder</p> <p>Verkocht per set (= 1 deur)</p>	<p>50 mm</p>
	<p>SUGPAW80 Inox wandmontage Boven en onder</p> <p>Verkocht per set (= 1 deur)</p>	<p>80 mm</p>
	<p>SUGPH50 Inox montage Boven en onder</p> <p>Verkocht per set (= 1 deur)</p>	<p>50 mm</p>
	<p>SUGPH80 Inox montage Boven en onder</p> <p>Verkocht per set (= 1 deur)</p>	<p>80 mm</p>
	<p>SUGPAS60 Inox kopsmontage Boven en onder</p> <p>Verkocht per set (= 1 deur)</p>	<p>60 mm</p>



 <p>80 mm</p>	<p>SUGPAS80 Inox kopsmontage Boven en onder</p> <p>Verkocht per set (= 1 deur)</p>	<p>80 mm</p>
	<p>PIV9560 Verende meubelspeun met kraag Demonteerbaar</p> <p>Verkocht per stuk</p> <p>(1 deur = 1 x PIV9560 + 1 x PIV9510 + 2 x PIV9511)</p>	
	<p>PIV9510 Verende meubelspeun met kraag</p> <p>Verkocht per stuk</p> <p>(1 deur = 1 x PIV9560 + 1 x PIV9510 + 2 x PIV9511)</p>	
	<p>PIV9511 Inboorhuls zonder kraag</p> <p>Verkocht per stuk</p> <p>(1 deur = 1 x PIV9560 + 1 x PIV9510 + 2 x PIV9511)</p>	

	<p>BPPH Smeedijzer pivot Boven en onder</p> <p>Verkocht per paar (= 1 deur)</p> <p>Enkel beschikbaar in gestookt onbehandeld ijzer</p>
	<p>BPPV Smeedijzer pivot Boven en onder</p> <p>Verkocht per paar (= 1 deur)</p> <p>Enkel beschikbaar in gestookt onbehandeld ijzer</p> <p>Zijdelingse montage</p>

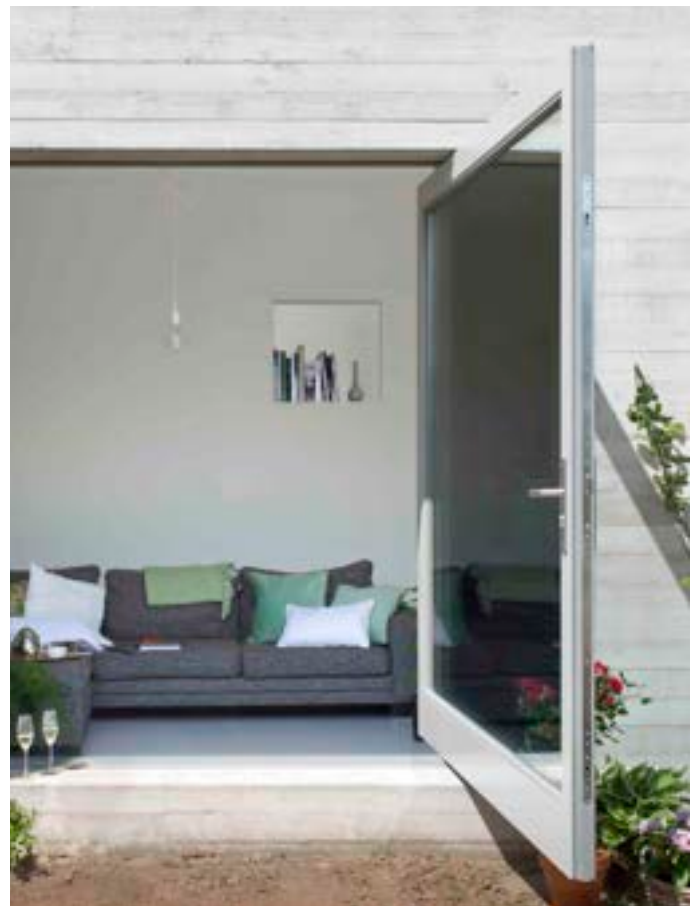

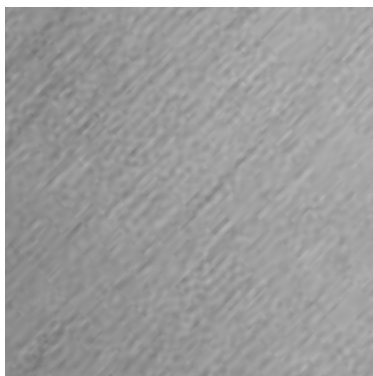

Inox geborsteld (IN)
IN STOCK

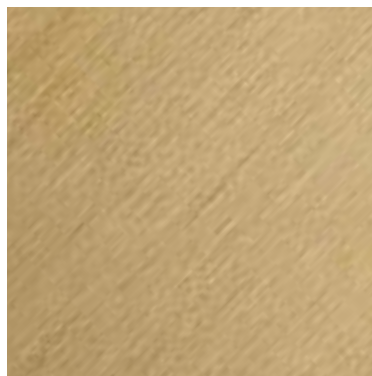

Messing brut (NV)
IN STOCK



Brons 1 (BR1)



Brons 3 (BR3)

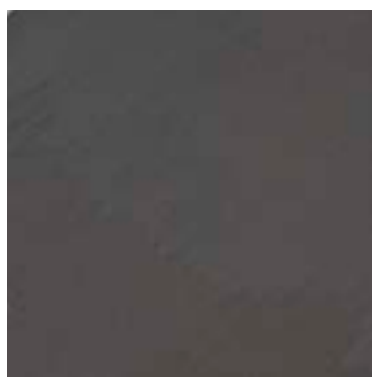

Canonfusil / zwart brons (CF)

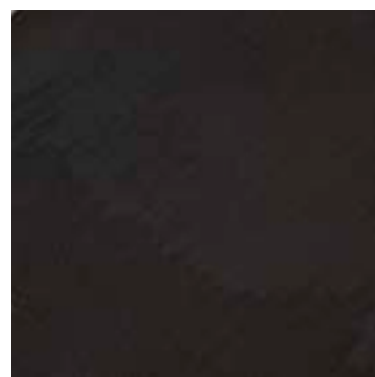









Zwart poederlak (ZW)

! Bij inox pivots worden er altijd messing rondsels geleverd. **!**

Alle pivots zijn in massief messing en in inox en verkrijgbaar in tal van afwerkingen.
Voor speciale toepassingen zijn de pivots ook op maat verkrijgbaar.

Stuur jullie ontwerp door en wij maken deze voor jullie met de nodige
nauwkeurigheid.

A		PIV1012 draaibaar zonder draad	D: 8 mm L: 190 mm B: 25
B		PIV1017 draaibaar zonder draad	D: 8 mm L: 150 mm B: 25
C		PIV1017A draaibaar met inkeping zonder draad	D: 8 mm L: 150 mm B: 25
D		PIV1018 draaibaar met draad	D: 8 mm L: 150 mm B: 25
E		PIV1018A draaibaar met inkeping met draad	D: 8 mm L: 150 mm B: 25
F		PIV1024 boven rechts / onder links	D: 8 mm L: 88 mm B: 25
G		PIV 1026 boven links / onder rechts	D: 8 mm L: 88 mm B: 25
H		PIV1023	L: 40 mm D: 20
I		PIV1022	M: 10 mm L: 21 mm Ø: 20 mm



Alle onderdelen zijn beschikbaar in diverse afwerkingen:

Inox geborsteld (IN) / Messing brut (NV) / Brons 1 (BR1) / Brons 3 (BR3) / Canonfusil - zwart brons (CF) / Zwart poederlak (ZW)
Inox en messing uit voorraad leverbaar. Diverse kleuren en afwerkingen zie kleurenkaart.

J		PIV1025	M: 10 mm L: 31,5 mm Ø: 20 mm
K		PIV1014	D: 2,5 mm Ø: 20 mm
X		PIV1030 zonder draad	D: 8 mm L: 88 mm B: 25



Alle onderdelen zijn beschikbaar in diverse afwerkingen:

Inox geborsteld (IN) / Messing brut (NV) / Brons 1 (BR1) / Brons 3 (BR3) / Canonfusil - zwart brons (CF) / Zwart poederlak (ZW)
Inox en messing uit voorraad leverbaar. Diverse kleuren en afwerkingen zie kleurenkaart.

L		PIV2019 draaibaar zonder draad	D: 6 mm L: 150 mm B: 16 mm
M		PIV2018 draaibaar met draad	D: 6 mm L: 108 mm B: 16 mm
N		PIV2017 draaibaar zonder draad	D: 6 mm L: 108 mm B: 16 mm
O		PIV2035 draaibaar met draad	D: 6 mm L: 108 mm B: 18 mm
P		PIV2039 draaibaar zonder draad	D: 6 mm L: 108 mm B: 18 mm
Q		PIV2030 zonder draad	D: 6 mm H: 70 mm Diepte: 51 mm B: 16 mm
R		PIV2034 boven rechts / onder links	D: 6 mm H: 70 mm B: 15
S		PIV2036 boven links / onder rechts	D: 6 mm H: 70 mm B: 15
T		PIV2023	L: 33 mm Ø: 12-16 mm



Alle onderdelen zijn beschikbaar in diverse afwerkingen:

Inox geborsteld (IN) / Messing brut (NV) / Brons 1 (BR1) / Brons 3 (BR3) / Canonfusil - zwart brons (CF) / Zwart poederlak (ZW)
Inox en messing uit voorraad leverbaar. Diverse kleuren en afwerkingen zie kleurenkaart.

U		PIV2016	M: 8 mm L: 17 mm Ø: 16 mm
V		PIV2025	M: 8 mm L: 27,5 mm Ø: 16 mm
W		PIV2014	Ø: 16 mm D: 2,5



Alle onderdelen zijn beschikbaar in diverse afwerkingen:

Inox geborsteld (IN) / Messing brut (NV) / Brons 1 (BR1) / Brons 3 (BR3) / Canonfusil - zwart brons (CF) / Zwart poederlak (ZW)
Inox en messing uit voorraad leverbaar. Diverse kleuren en afwerkingen zie kleurenkaart.



LATCH CONTROL & SPEED CONTROL DANKZIJ DE NIEUWE SYSTEM M+!

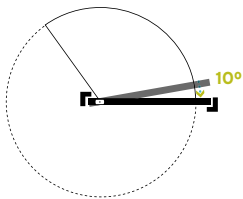

LATCH CONTROL

Biedt de mogelijkheid de scharnieren zo in te stellen zodat de deur altijd goed in het slot valt.

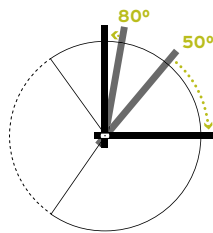

DAMPER CONTROL

Creëert een soepele en elegante sluitbeweging en beschermt de deur tegen aanrakingen met de muur (hydraulische openingsdemping).

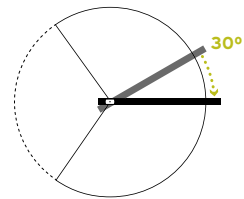

30° SPEED CONTROL

Maakt het mogelijk de snelheid van de taatsdeur in het laatste deel van de sluitingsbeweging te bepalen.

NIEUW



SET SYSTEM M+

Verkocht per set (= 1 deur)

Verkrijgbaar in 7 verschillende types;
A, B, C, D, E, F of G (meer info zie onze website)

Plafond- en vloerplaat beschikbaar in inox of zwart

	<p>SET SYSTEM M Verkocht per set (= 1 deur)</p> <p>Verkrijgbaar in 4 verschillende types; AA, A, B of C (meer info zie onze website)</p> <p>Plafond- en vloerplaat beschikbaar in inox of zwart</p>
	<p>BOVENSPEUN</p>
	<p>BOVENSPEUN MET KABELDOORGANG</p>
	<p>PLAFONDPLAAT Beschikbaar in inox of zwart</p>
	<p>PLAFONDPLAAT MET KABELDOORGANG Enkel beschikbaar in inox</p>
	<p>ZESKANT STAAF Beschikbaar in 750 mm, 1500 mm of 3000 mm</p>
	<p>HEXAGON GUIDE Eenvoudig afstellen van bovenspeun</p>



PIVOTICA SET

Verkocht per set (= 1 deur)

Voor deuren tot 45 kilo

Enkel beschikbaar in inox uitvoering



PIVOTICA PRO 100 SET

Verkocht per set (= 1 deur)

Voor deuren tot 100 kilo

Plafond- en vloerplaat beschikbaar in inox of zwart



PIVOTICA PRO 150 SET

Verkocht per set (= 1 deur)

Voor deuren tot 150 kilo

Met of zonder vasthoudpositie

Plafond- en vloerplaat beschikbaar in inox of zwart



CIR ONZICHTBAAR SET

Verkocht per set (= 1 deur)

Voor deuren tot 70 kilo

Links en rechts bruikbaar
3 mm verstelbaar



DCDF100

Regelbare bovenpivot

Geschikt voor situaties met harde structuur
(beton, metaal)

Te combineren met onderpivot van diverse merken
Draaipunt vanaf 15 mm van de kant



DOR8062

Bovenpivot Dorma



DOR8064

Afdekplaat inox voor DOR8062

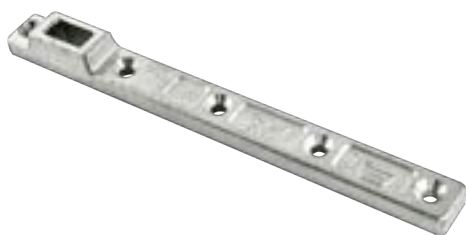

DOR7421

Onderspeun Dorma



MABAC299

Onderpivot



JNF05204

Pivot houten deuren
Verkocht per set (= 1 deur)

Maximum 100 kg



DCDF81203

Pivot glazen deuren
Verkocht per set (= 1 deur)

Maximum 100 kg

NIEUW



JNF05208

Onzichtbare pivot
Verkocht per set (= 1 deur)

Met onder en bovenspeun
Voor houten deuren
Maximum 65 kg

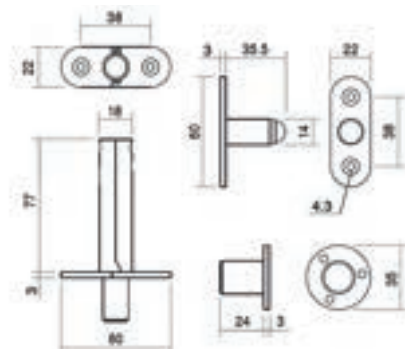

DECEUNINCK - DEFORCE NV

Openingsuren

Ma - Do: 08u - 12u / 13u - 17.30u
Vr: 08u - 12u / 13u - 15u | Za: 09u - 12u

Toonzaal

Ma - Do: 08u - 12u / 13u - 17.30u
Vr: 08u - 12u / 13u - 15u | Za: 09u - 12u

Lodewijk De Raetlaan 28, 8870 Kachtem

T +32 (0)51 22 41 11
info@dcd.be



Leveringen doorheen gans België!



Lodewijk De Raetlaan 28 8870 kachtem

